



CAMPBELL SECURITY SCREEN PROTECTIVE SECURITY WINDOWS

CUSTOM WINDOW (HEIGHT) GUIDELINES:
 FIRE ESCAPE = 29.07" RECOMMENDED MIN HEIGHT
 FIRE ESCAPE = 127.49" RECOMMENDED MAX HEIGHT

CUSTOM WINDOW (WIDTH) GUIDELINES:
 FIRE ESCAPE = 13.36" RECOMMENDED MIN WIDTH
 FIRE ESCAPE = 71.02" RECOMMENDED MAX WIDTH

OPTIONS:
 MID-RAIL OPTIONS - VERTICAL AND HORIZONTAL:
 (DETAIL 3/1.01)

- COLOR OPTIONS:
- WHITE
 - BLACK
 - BROWN
 - SAHARA BROWN
 - LIGHT GRAY
 - SILVER
 - ALMOND
 - BRONZE
 - SAHARA GRAY
 - CUSTOM

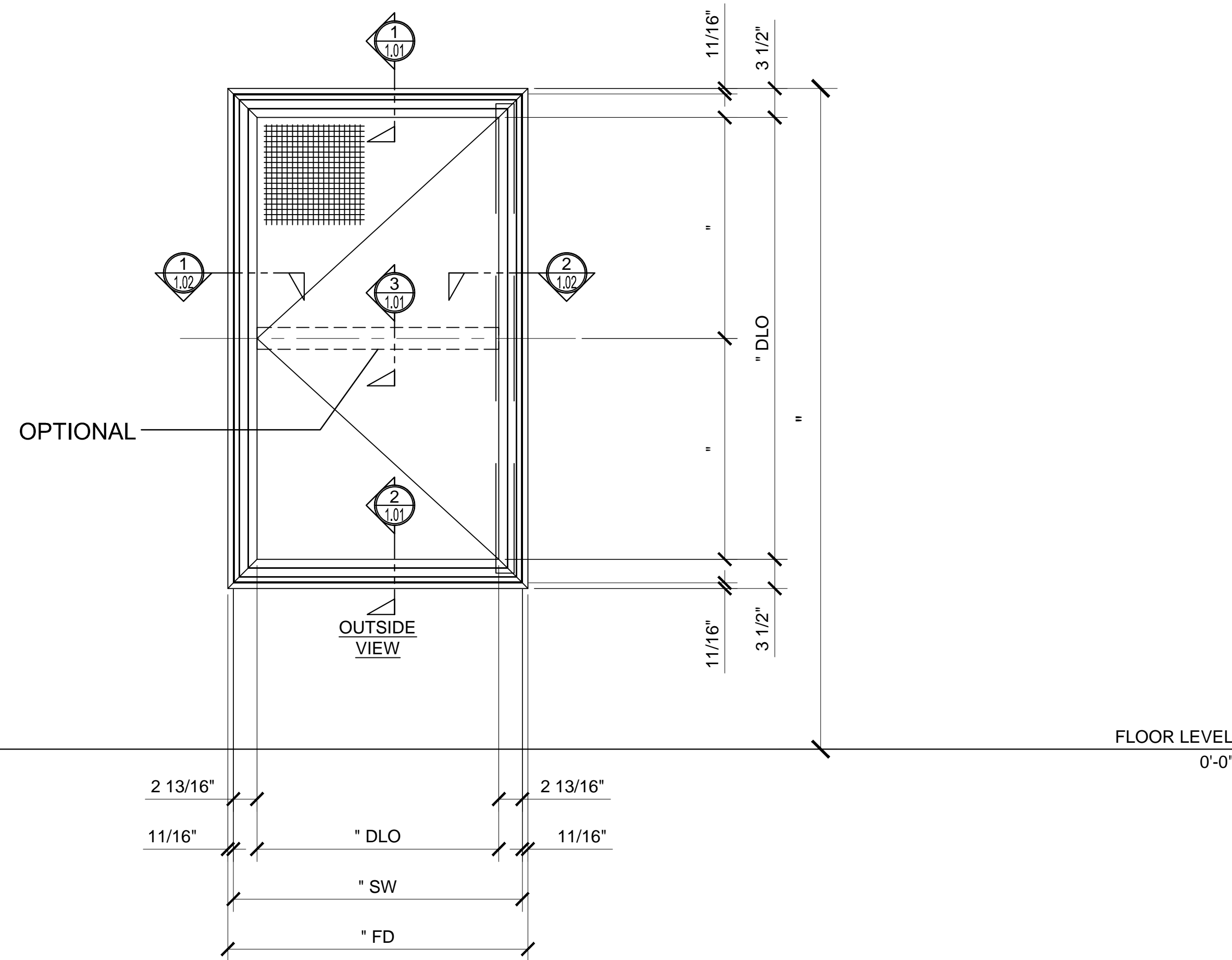

FIRE ESCAPE SIDE HUNG WINDOW

WINDOW SWING CHART

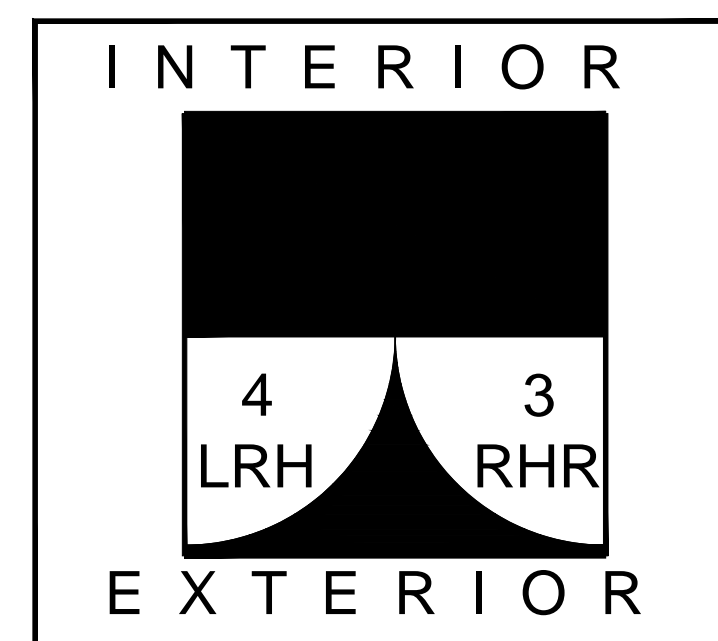

STRUCTURAL DISCLAIMER:

ALL CUSTOMERS WHO IN ANY WAY UTILIZE THIS PRODUCT ARE SOLELY RESPONSIBLE TO CONSULT A STRUCTURAL ENGINEER TO DETERMINE THE SUITABILITY OF THE PRODUCT FOR THE INTENDED USE AND SITE CONDITIONS. ALL INSTALLERS MUST BE QUALIFIED AND HAVE PROFESSIONAL KNOWLEDGE ABOUT COMPLIANCE WITH LOCAL, STATE AND FEDERAL REGULATIONS, SAFETY FACTORS, AND THE APPROPRIATE CHOICE OF FIXING MATERIAL AND PROCEDURES.





CAMPBELL SECURITY SCREEN PROTECTIVE SECURITY WINDOWS

CUSTOM WINDOW (HEIGHT) GUIDELINES:
 FIRE ESCAPE = 29.07" RECOMMENDED MIN HEIGHT
 FIRE ESCAPE = 127.49" RECOMMENDED MAX HEIGHT

CUSTOM WINDOW (WIDTH) GUIDELINES:
 FIRE ESCAPE = 13.36" RECOMMENDED MIN WIDTH
 FIRE ESCAPE = 71.02" RECOMMENDED MAX WIDTH

- OPTIONS:**
- MID-RAIL OPTIONS - VERTICAL AND HORIZONTAL:**
 (DETAIL 3/1.01)
- COLOR OPTIONS:**
- WHITE
 - BLACK
 - BROWN
 - SAHARA BROWN
 - LIGHT GRAY
 - SILVER
 - ALMOND
 - BRONZE
 - SAHARA GRAY
 - CUSTOM

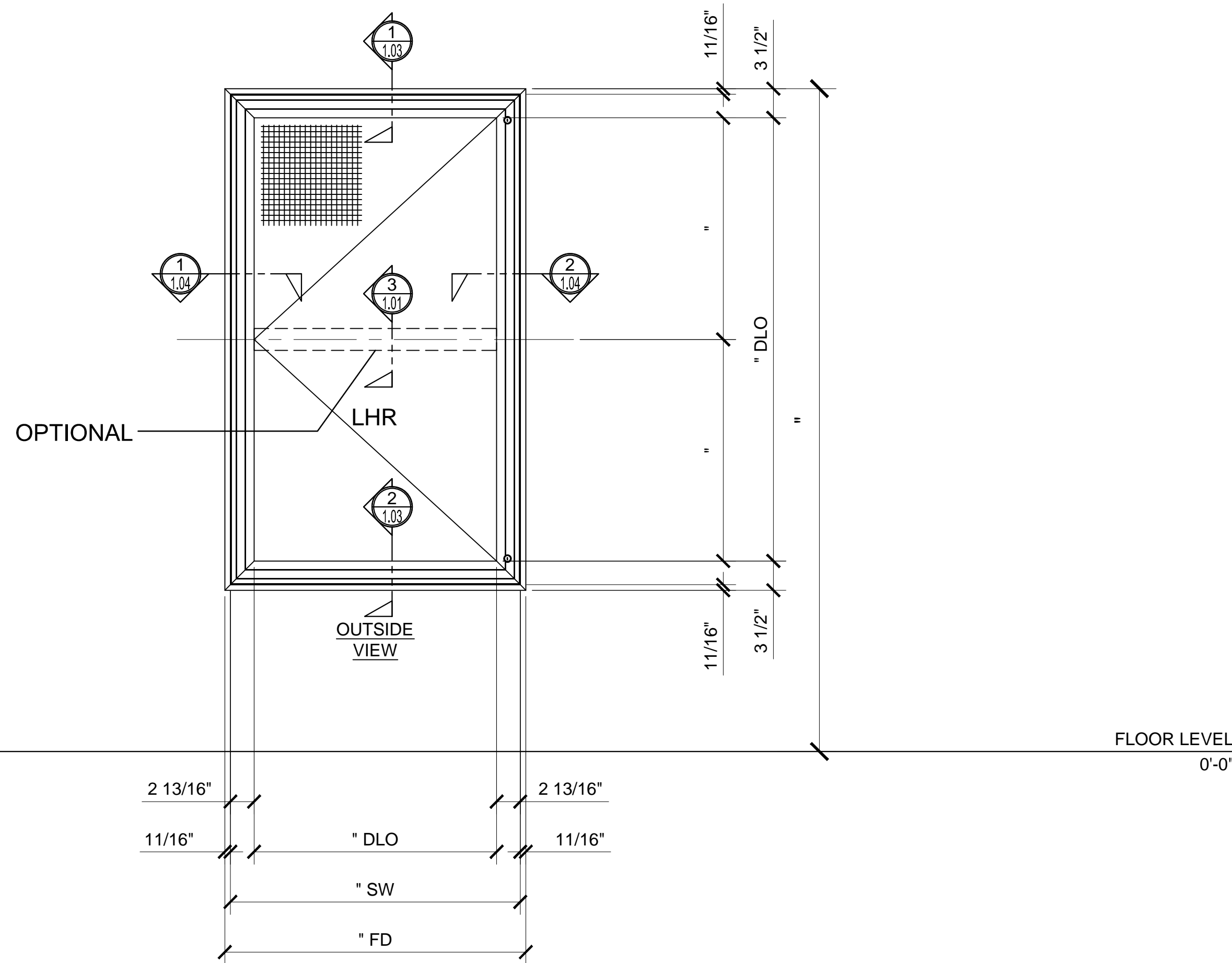

FIRE ESCAPE KEY LOCK LEFT SIDE HUNG WINDOW

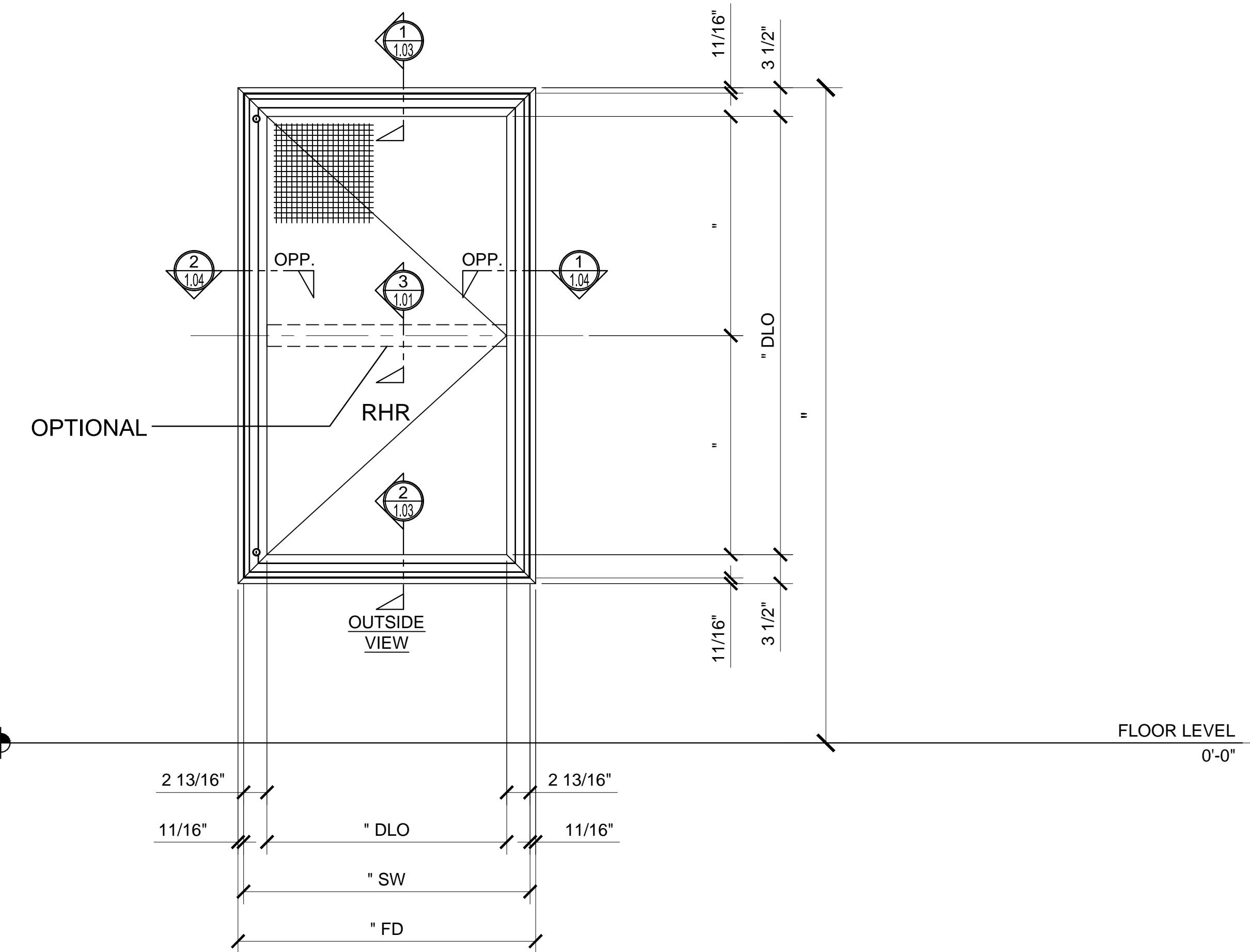

FIRE ESCAPE KEY LOCK RIGHT SIDE HUNG WINDOW

WINDOW SWING CHART

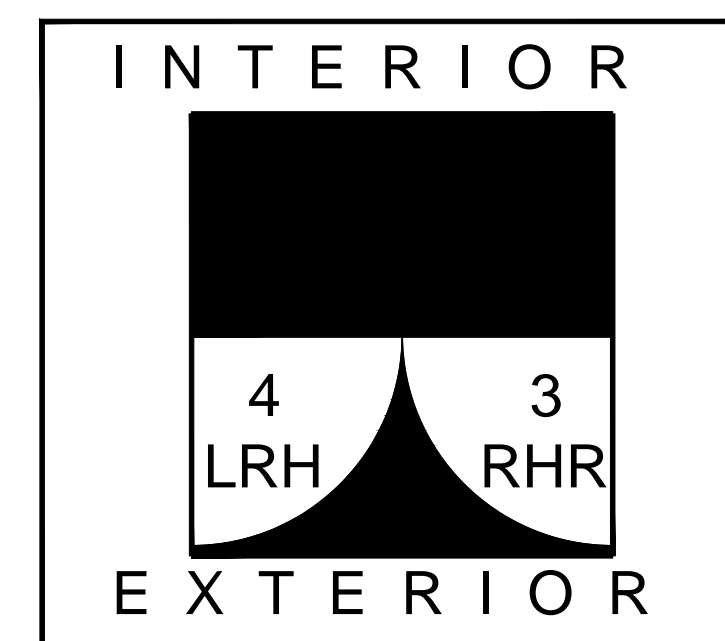

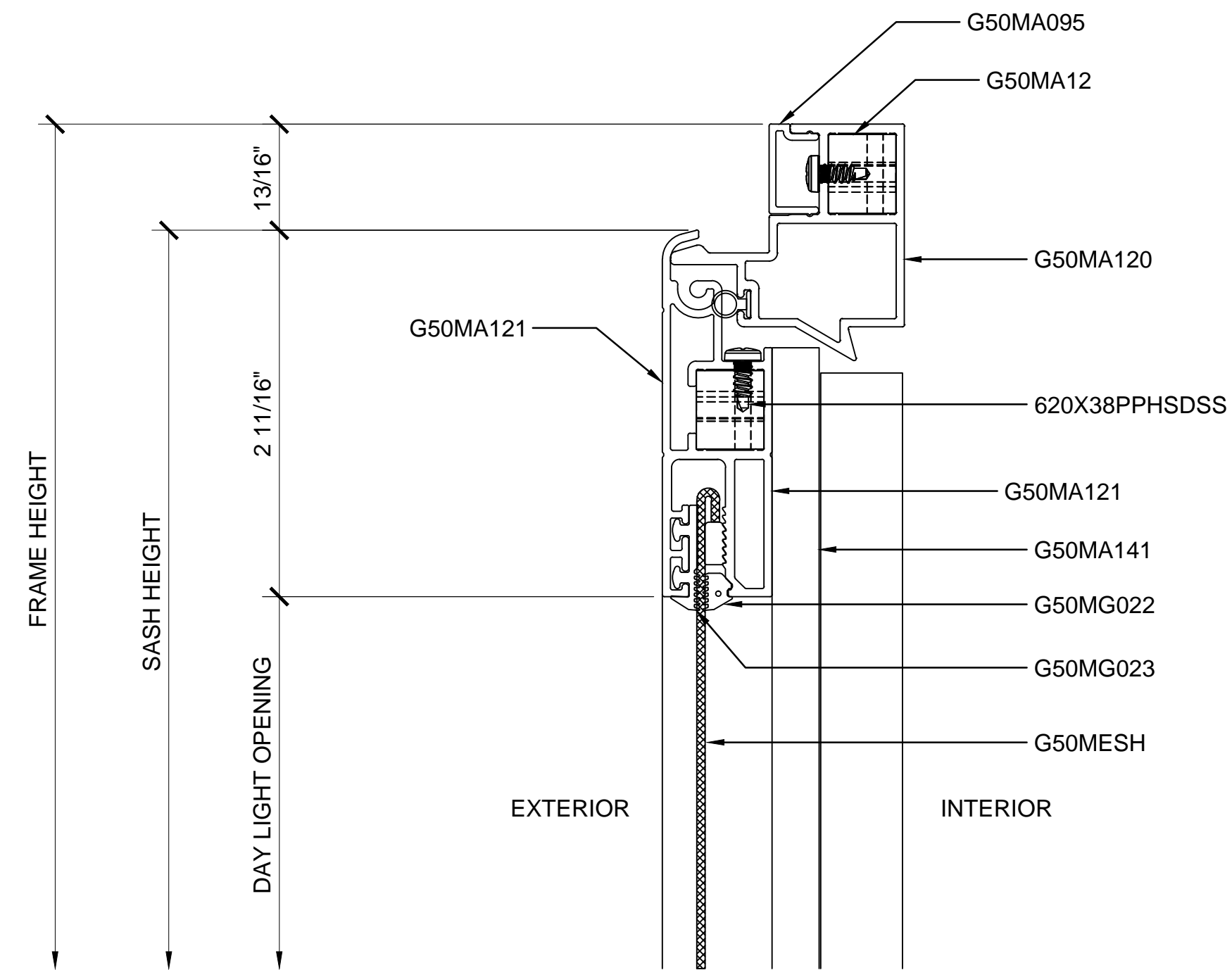

① SECTION DETAIL AT HEAD

ARCH REF: N/A

1'-0"=1'-0"

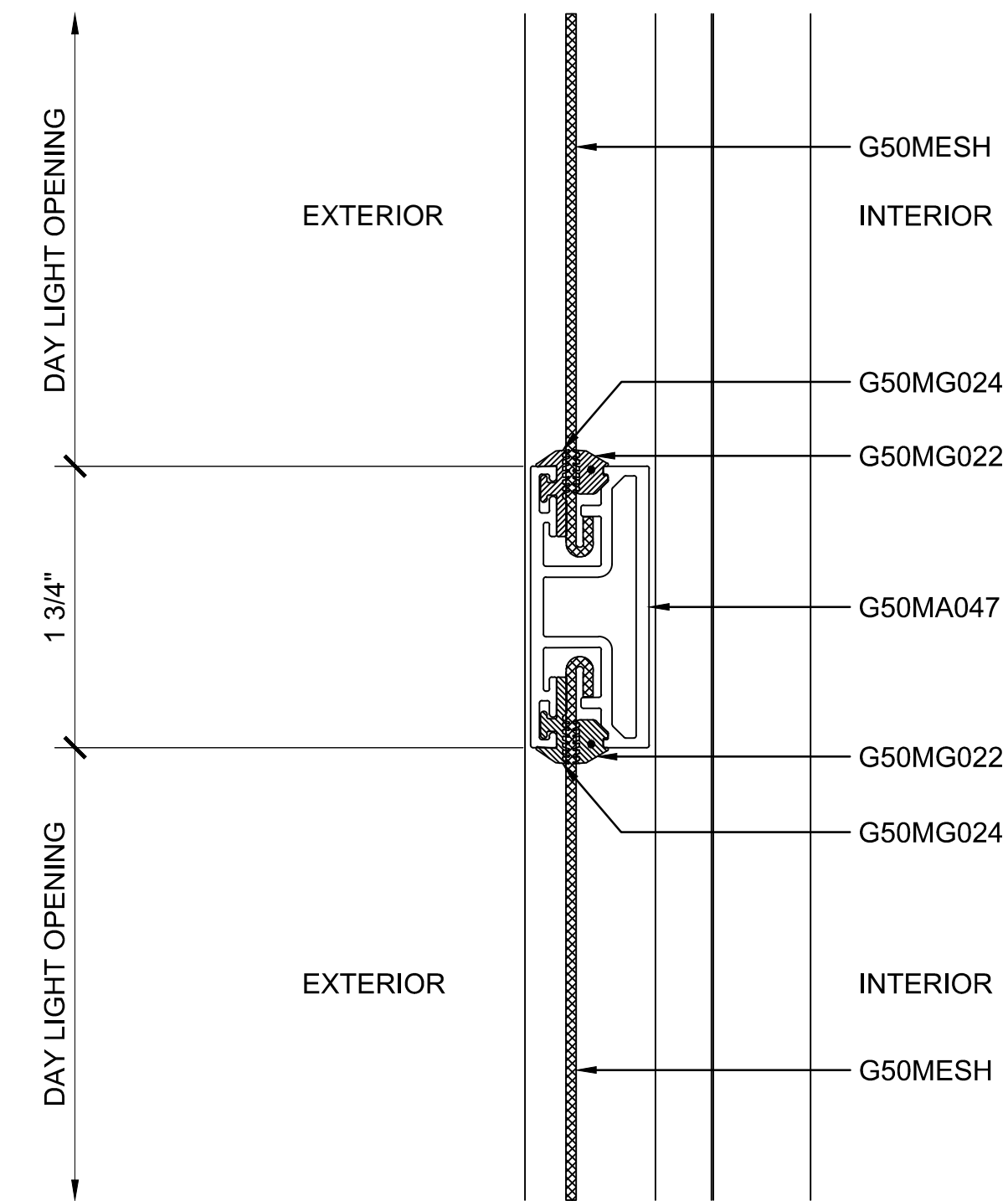

③ SECTION DETAIL AT MIDRAIL - OPTIONAL

ARCH REF: N/A

1'-0"=1'-0"

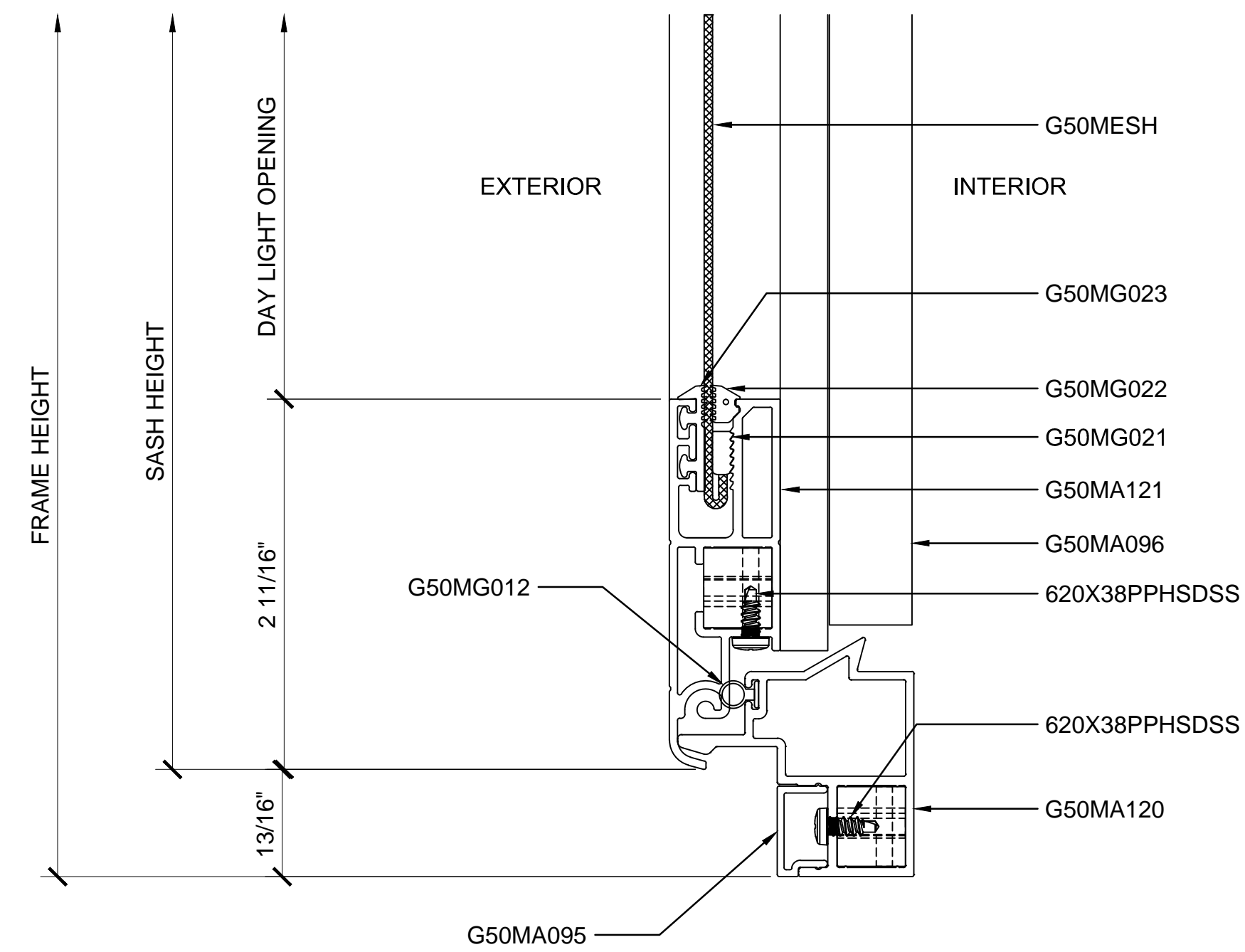

② SECTION DETAIL AT SILL

ARCH REF: N/A

1'-0"=1'-0"

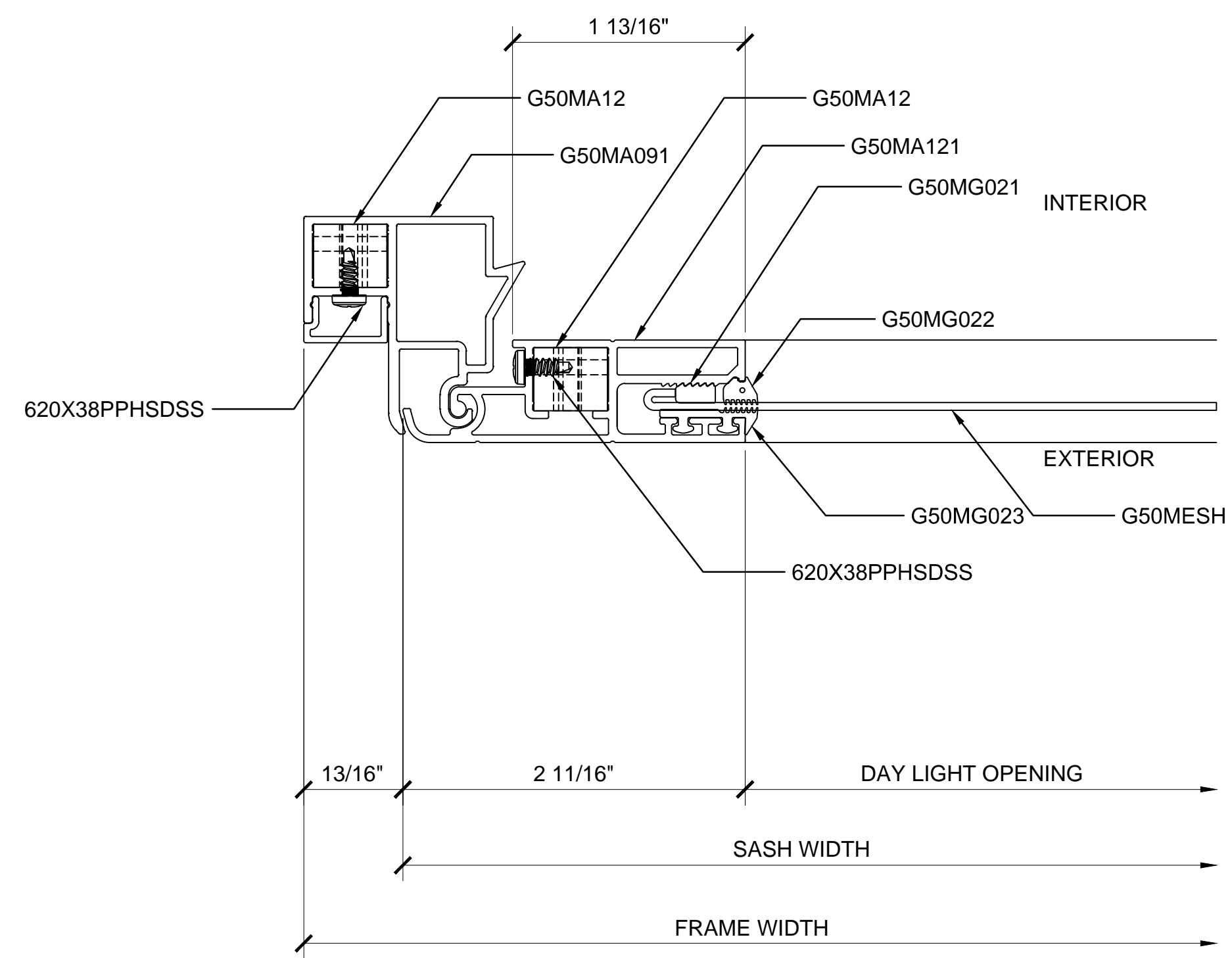

① SECTION DETAIL AT JAMB

ARCH REF: N/A

1'-0"=1'-0"

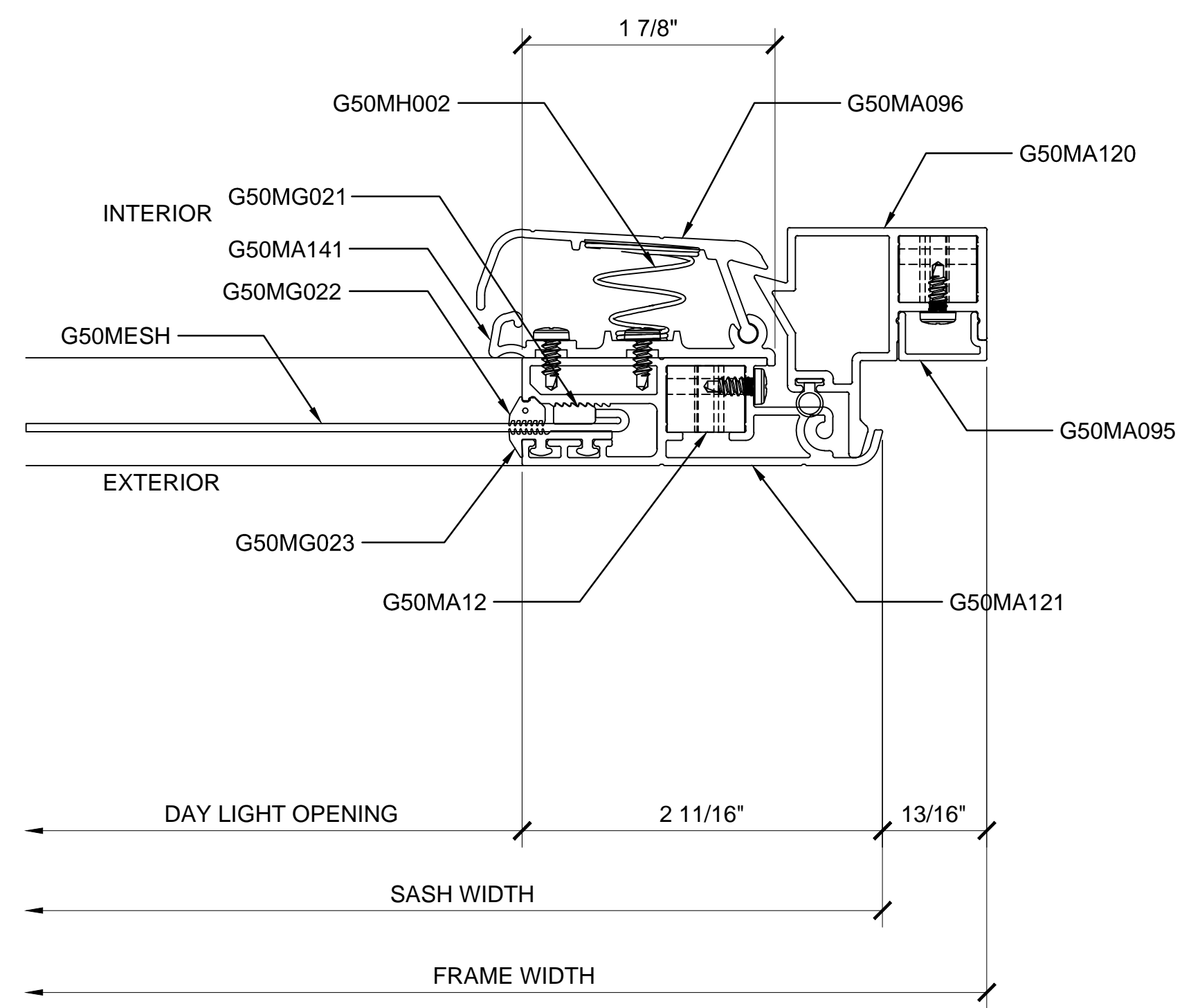

② SECTION DETAIL AT JAMB

ARCH REF: N/A

1'-0"=1'-0"



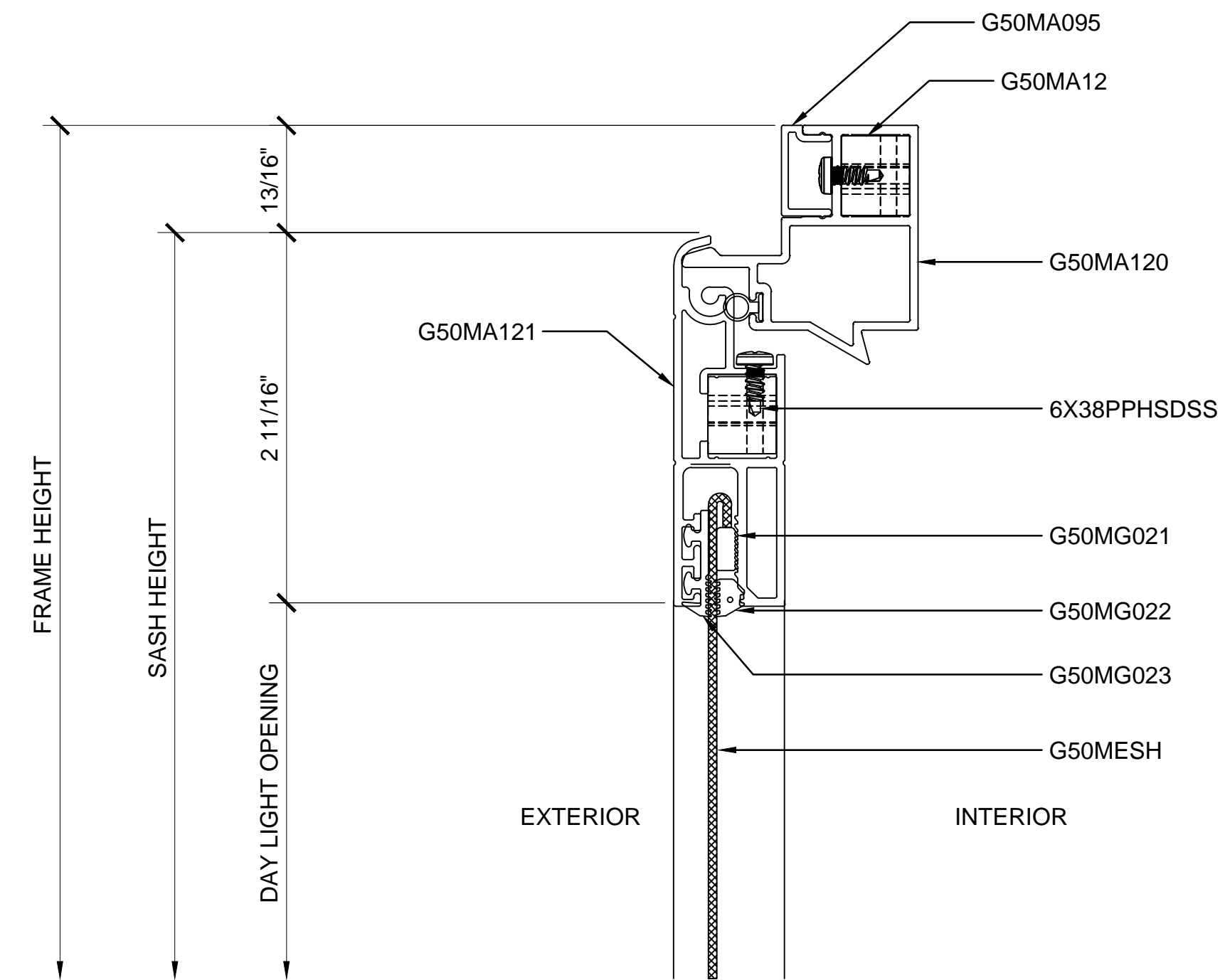

① SECTION DETAIL AT HEAD

ARCH REF: N/A 1'-0"=1'-0"

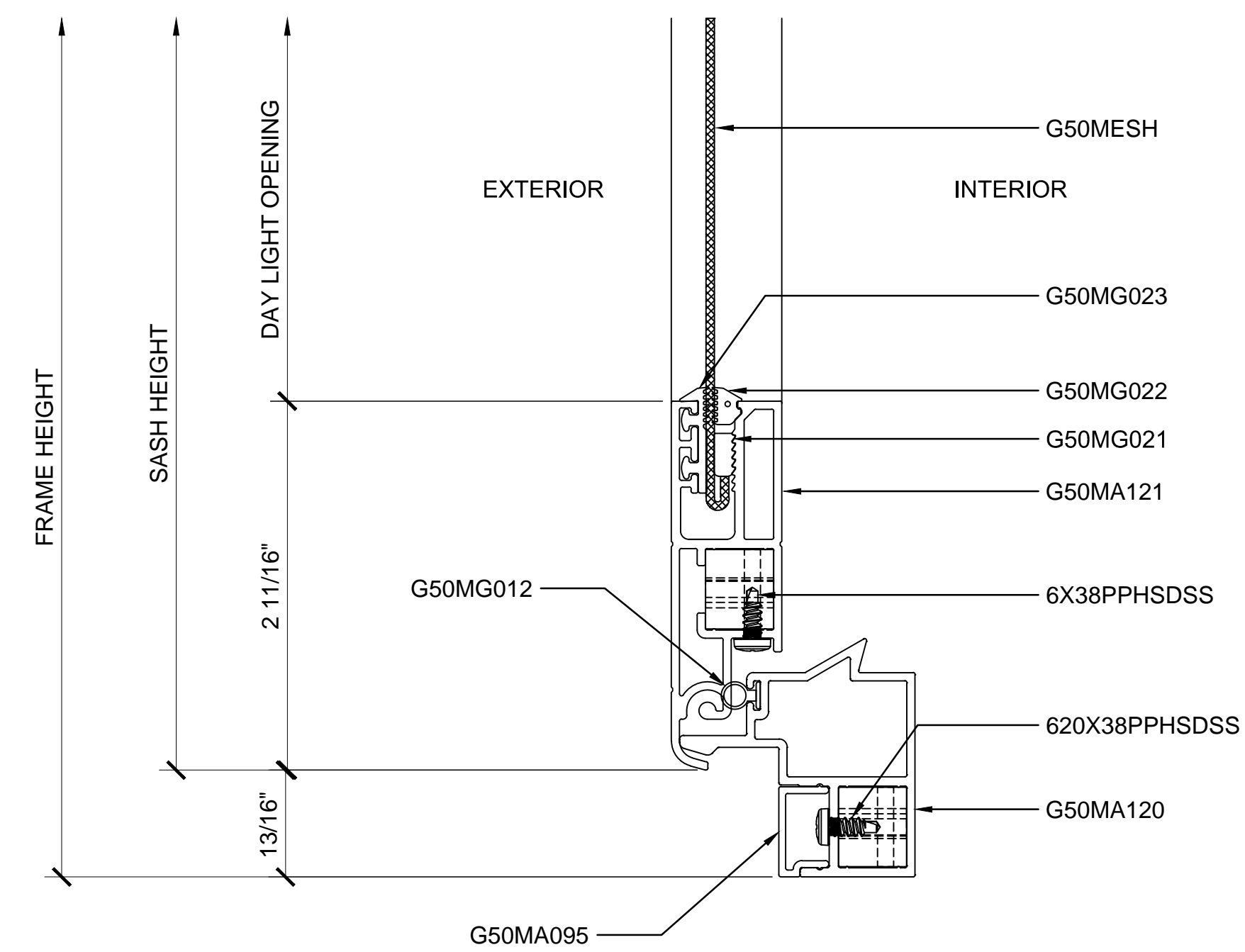

② SECTION DETAIL AT SILL

ARCH REF: N/A 1'-0"=1'-0"

FIRE ESCAPE KEY LOCK SIDE HUNG WINDOW DETAILS



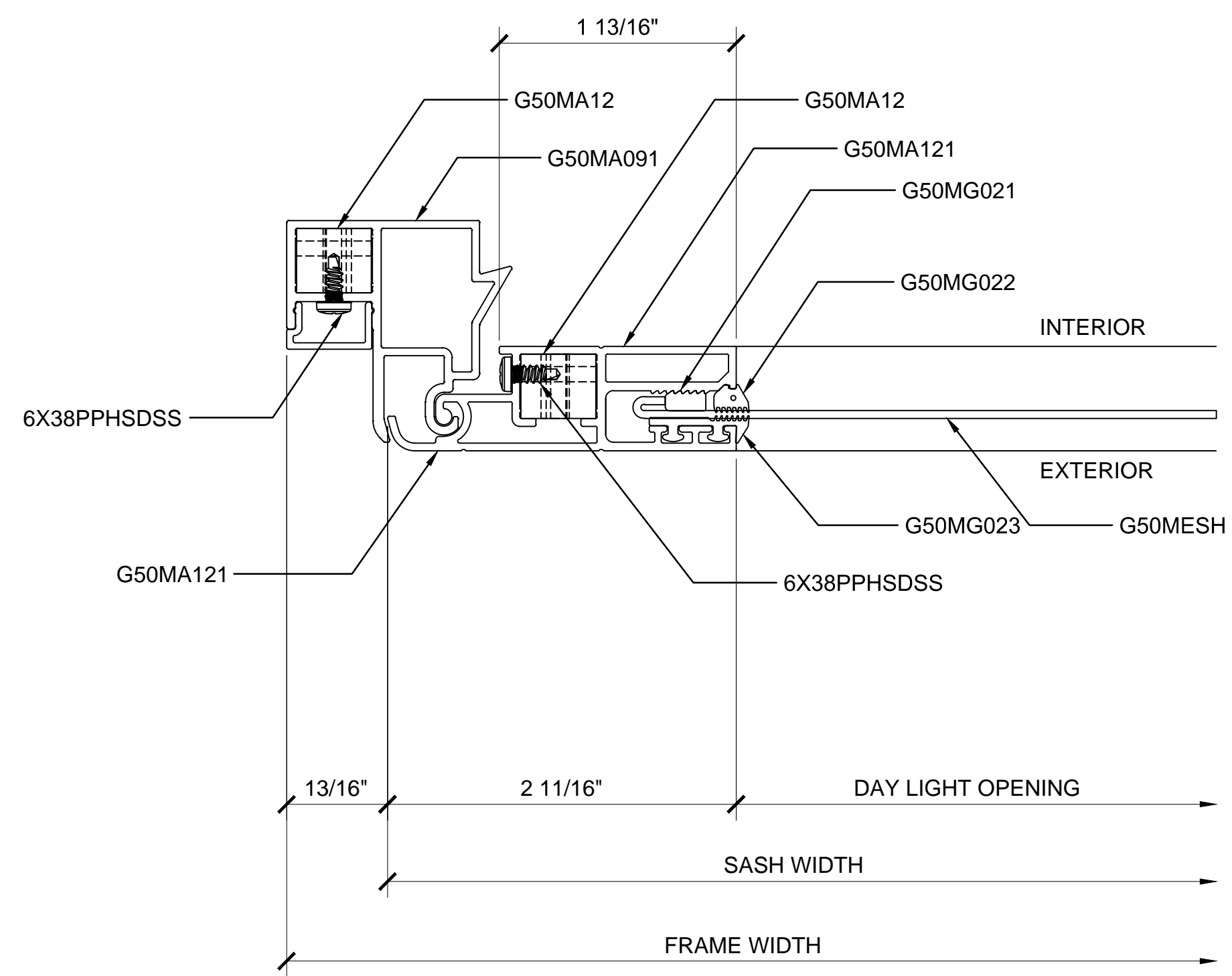

① SECTION DETAIL AT JAMB

ARCH REF: N/A

1'-0"=1'-0"

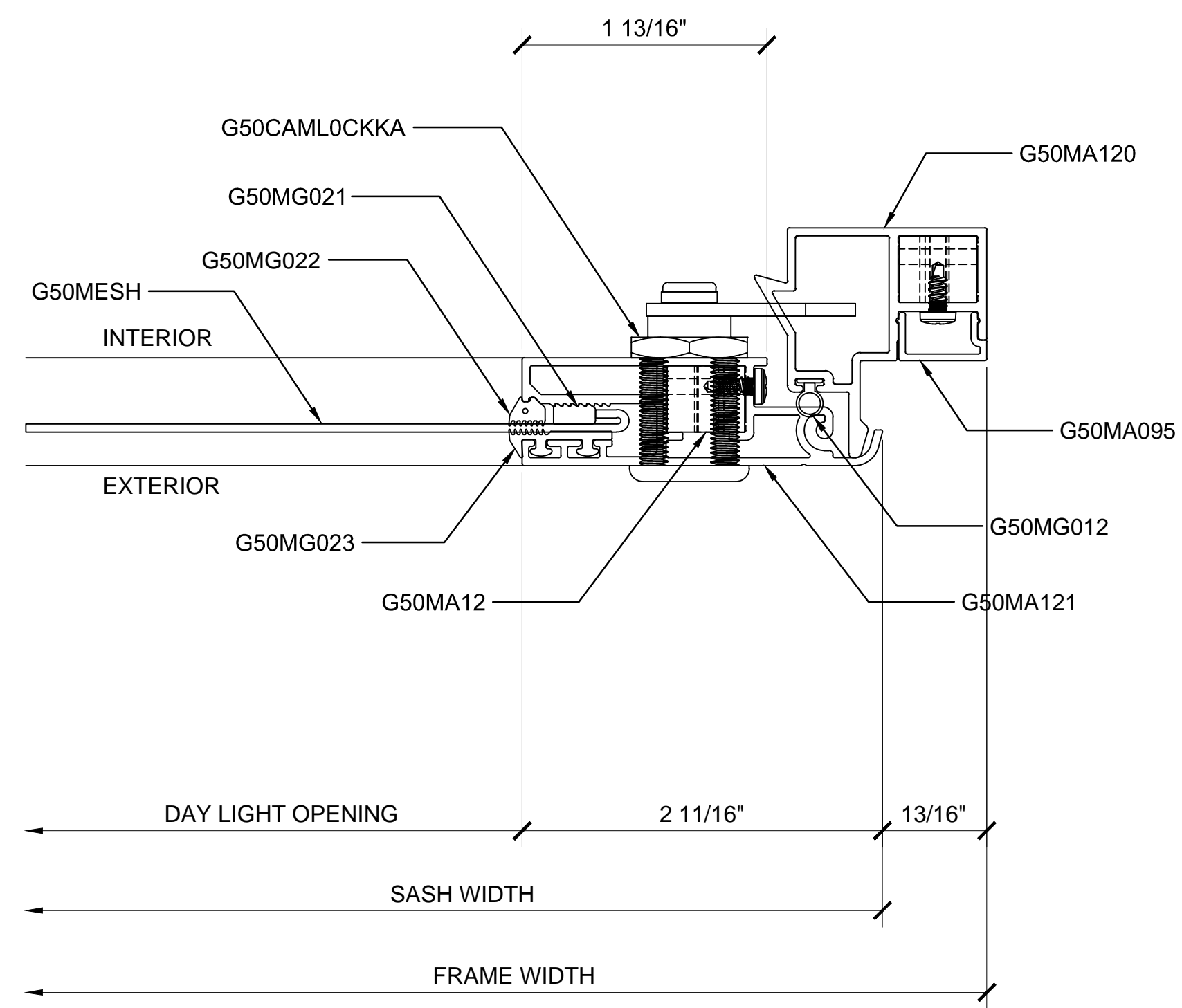

② SECTION DETAIL AT JAMB

ARCH REF: N/A

1'-0"=1'-0"

